

2 way flanged polished ball valve from ingot, stainless steel AISI 304, full bore, with electric actuator series 85.(Self-Extinguish Technopolymer Enclosure)

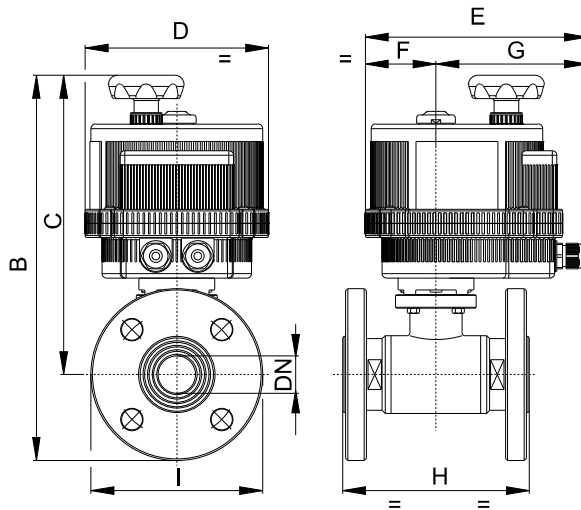

Art. 8E012***

DN	10	15	20	25	32	40	50	65	80	100
PN	40	40	40	40	40	40	40	16	16	16
B	226	231	240	298	365	366	382	420	438	462
C	181	183	187	240	295	291	299	327	338	352
D	123	123	123	157	157	185	185	211	211	211
E	164	164	164	191	191	215	215	237	237	237
F	43	43	43	61	61	68	68	84	84	84
G	121	121	121	130	130	147	147	153	153	153
H	110	115	120	125	130	140	150	170	180	190
I	90	95	105	115	140	150	165	185	200	220
ACT.	VB 015	VB 015	VB 015	VB 030 *	VB 030 *	VB 060	VB 060	VB 110	VB 110	VB 110

* SPECIAL VERSION

*** VOLTAGE SUPPLY ORDER CODE		
12V AC/DC + 001	24V AC/DC + 002	100-240V AC + 004